

*по сборке стеллажа СтМ*



1.

:

1.1.

6 14, (2-

1.2.

).

),

6 14

2.

« »:

	:	:
300 .		30
400 .		40
500 .		50
600 .		60
700 .		70
800 .		80

1000	1	1	2	4
1500	1	1	2	4
1800	1	1	2	4
2000	1	1	2	4
2300	1	1	2	4
2500	1	1	2	4

			6 14	-
- L 300	3	2	16	4
- L 400	4	2	16	6
- L 500	5	2	16	8
- L 600	6	2	16	1
- L 700	7	2	16	1
- L 800	8	2	16	1

L -

		-	6 14
300	1	2	8
400	1	3	8
500	1	4	8
600	1	5	8
700	1	6	8
800	1	7	8
700 100	-	-	-
1000 100	-	-	-
1200 100	-	-	-
1500 100	-	-	-
1800 100	-	-	-

3.

- :  
 -  
 - 6 14 , 2- 6,  
 - ,

2-

4-

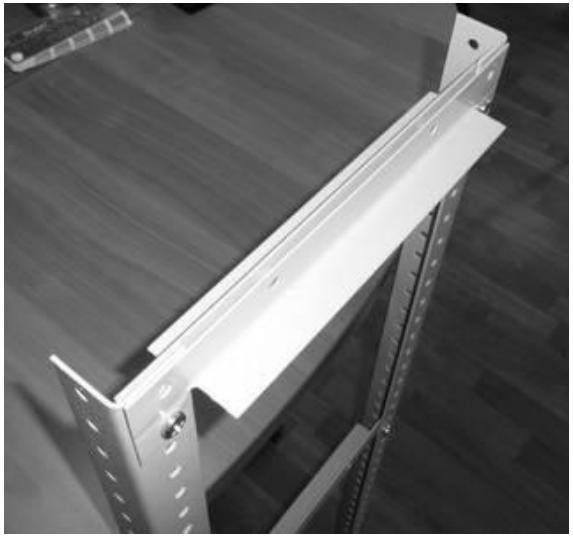
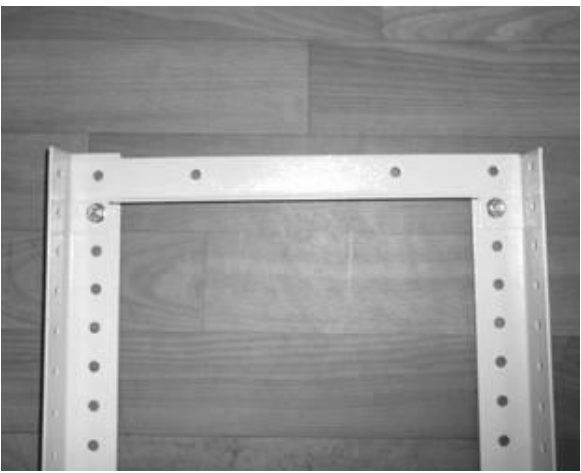
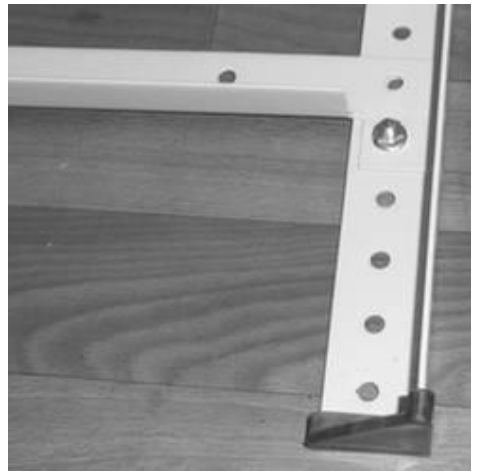

,  
 : \*  
 ,  
 - :  
 - ,  
 - 6.

6 14

6.

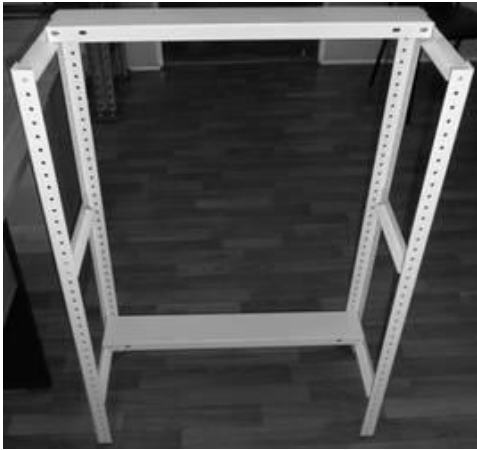

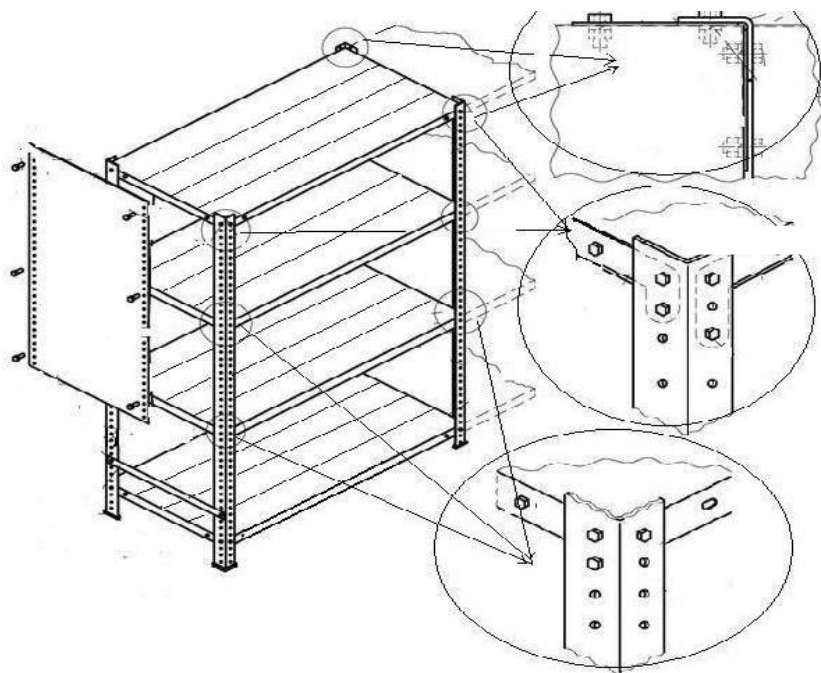
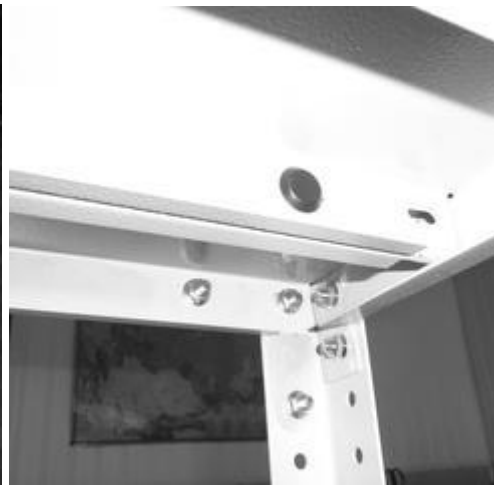

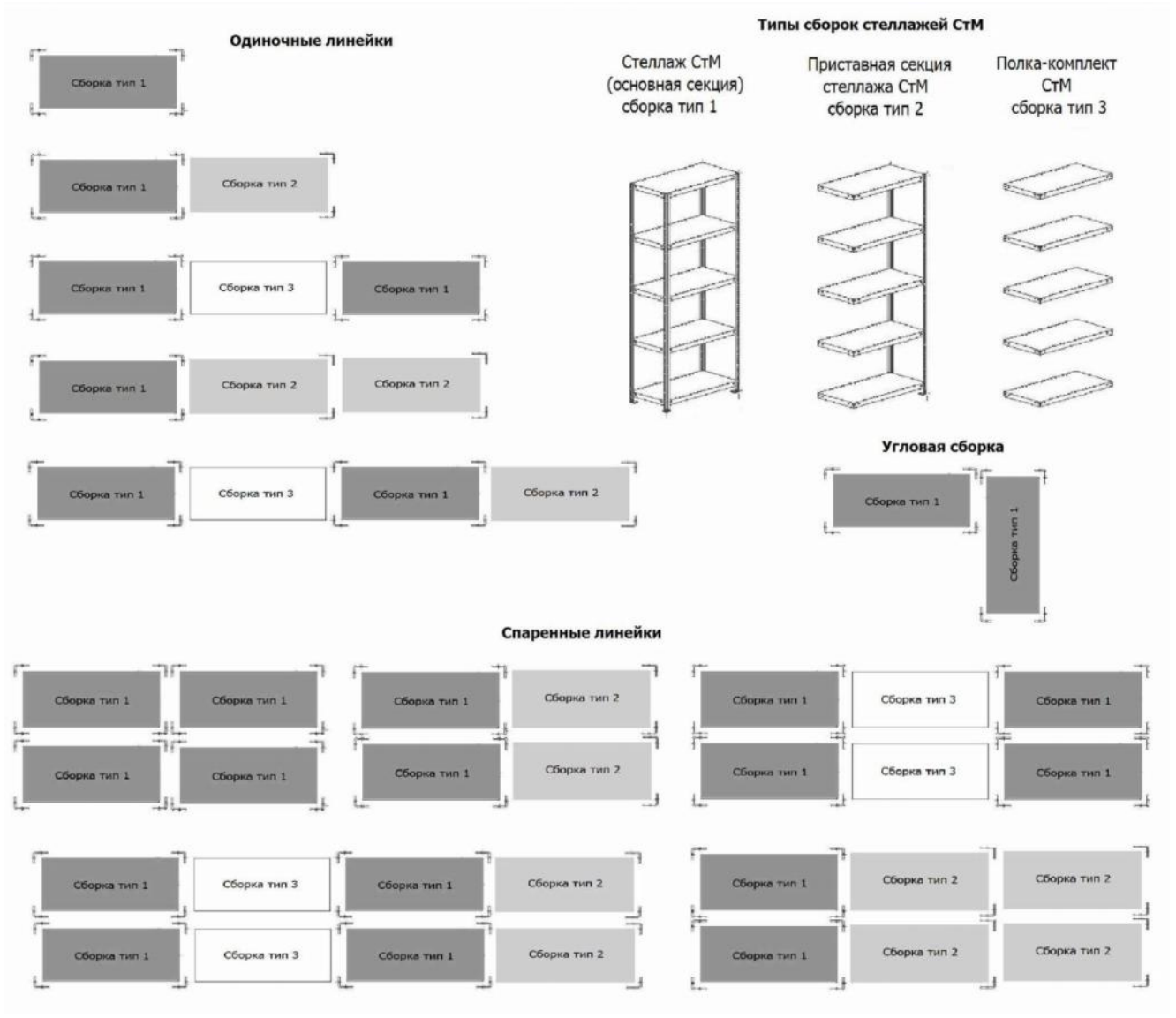

:				
,	1	4	4	-
,	2	2	2	-
3	-	-	-	-
-				
!				